

A Sampling of High Performance Floor & Surface Coating Tools

MIDWEST RAKE®

EASYSQUEEGEE™
CLEANABLE & REUSABLE PATENT PENDING, US
PRECISION APPLICATION SQUEEGEE SYSTEM

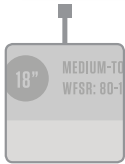
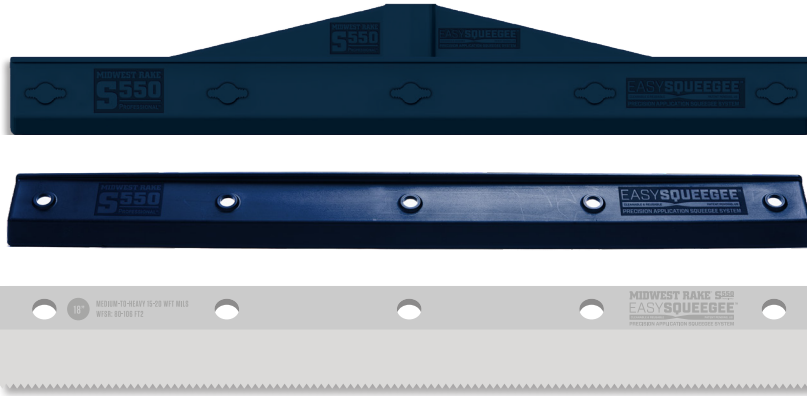

INTELLIGENT BLADE IDENTIFICATION
 All blades inscribed with WFT and WFSR information.



SELF-LEVELING BLADES
 Accurate and predictable Wet Film Thickness every time.



SELF-LOCATING BLADES
 Designed to provide industry leading accuracy.



PROTECTED THREADS AND FASTENERS
 Eliminates material contact with threads.



THUMB SCREWS REPLACE NUTS
 Features Cured Coatings Release (CCR™) Technology for cleanability.

FRAME & BLADE STYLE	BLADE WIDTH / PART NUMBER			
	18"	19"	26"	27"
FRAME REPLACEMENT THUMB SCREWS - 79849	78255		78256	
FLAT FLEXIBLE		79850		79851
FLAT STIFF	79853		79854	
5-7 WFT MILS WFSR: 230-320 FT ² / GAL	79856		79857	
8-12 WFT MILS WFSR: 133-200 FT ² / GAL	79859		79860	
15-20 WFT MILS WFSR: 80-106 FT ² / GAL	79862		79863	
25-30 WFT MILS WFSR: 53-64 FT ² / GAL	79865		79866	
40-45 WFT MILS WFSR: 36-40 FT ² / GAL	79868		79869	
50-60 WFT MILS WFSR: 26-32 FT ² / GAL	79871		79872	

ALL BLADE PACKAGING COLOR CODED FOR EASY IDENTIFICATION

WFT = WET FILM THICKNESS | WFSR = WET FILM SPREAD RATE | GAL = GALLON

Speed Squeegees

The choice among epoxy flooring, deck coating, and decorative concrete contractors who prefer a softer blade. Red santoprene provides excellent chemical resistance and is non-marking.

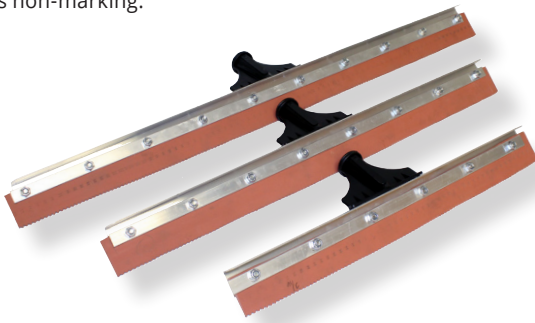

47150	Speed Squeegee, 24" Flat, Red Rubber
47151	Speed Squeegee, 24", 1/8" Notch, Red Rubber
47152	Speed Squeegee, 24", 3/16" Notch, Red Rubber
47153	Speed Squeegee, 24", 1/4" Notch, Red Rubber
47160	Speed Squeegee, 30" Flat, Red Rubber
47161	Speed Squeegee, 30", 1/8" Notch, Red Rubber
47162	Speed Squeegee, 30", 3/16" Notch, Red Rubber
47163	Speed Squeegee, 30", 1/4" Notch, Red Rubber

CAM® Gauge Rakes



57000 - 24" with Threaded Handle Adapter (Frame Only)
57001 - 24" with Powder-Coated Aluminum Handle

A patented "goof-proof" tool which applies materials at a precise, uniform depth. Apply decorative concrete "toppings," self leveling / high performance floor coating materials, and underlayments. CAM® depth settings range from 1/32" to 1-1/2". Includes an aluminum frame with either a threaded handle adapter or a powder-coated aluminum handle. Choose your frame size and handle option and then choose your CAM® set. Frames and sets are sold separately.

When one contact point wears down, you simply loosen the wing nut and rotate the CAM® to a fresh contact point. We use a "radial" edge design which maintains uniform coating thickness, even at varying handle angles and lengths.

Other sizes available



1/16" - 57081



1/8" - 57082



3/8" - 57086

Footwear

Black Spiked Shoes

- Durable solvent-resistant polypropylene
- Snap-lock buckle system
- Sharp or rounded tip spikes
- 3/4", 1" and 1-1/2" spike lengths
- 13 specially placed spikes per shoe

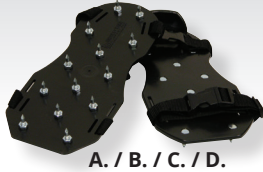

A. / B. / C. / D.

Steel Spiked Shoes

- More flexible and durable
- Snap-lock buckle system
- 3/4" or 1" spike lengths



Non-puncturing rounded tip available



E. / F.



G.

Red "Acid-Resistant" Spiked Shoes

- 3/4" acid-resistant stainless steel spikes
- Acid-resistant footbeds
- Snap-lock buckle system
- Replacement sharp spikes (see below)

Item No.	Description
A. 46106	Black Spiked Shoes 3/4" Sharp Spikes (Pair)
B. 46107	Black Spiked Shoes 1" Sharp Spikes (Pair)
C. 46110	Black Spiked Shoes 1-1/2" Sharp Spikes (Pair)
D. 46112	Black Spiked Shoes 1" Rounded Spikes (Pair)
E. 46103	Steel Spiked Shoes with 3/4" Sharp Spikes (Pair)
F. 46104	Steel Spiked Shoes with 1" Sharp Spikes (Pair)
G. 46108	Red "Acid-Resistant" Sharp Spiked Shoes (Pair)

Concrete Finishing & Resinous Floor Coating Shoes

It's never been easier to install epoxy coatings or self-leveling and decorative overlays. With a patented design, Shoe-In® Pro shoes are a fantastically simple and affordable solution with multiple applications.

Shoe-In® - Sharp Spiked Style



- For resinous / epoxy floor coating installation
- Mark-free installations
- Sharp or rounded replacement spikes available



APPLICATIONS INCLUDE:

- Installing Epoxy Coatings
- Installing Concrete & Screed Floors Including Decorative Overlays
- Industrial Environments
- Renovations or Removals
- Any Area Where Flooring Needs Protecting

Item No.	Description
46171	Spiked Shoes - 3/4" Sharp - for Resinous Coatings - Medium
46172	Spiked Shoes - 3/4" Sharp - for Resinous Coatings - Large
46173	Spiked Shoes - 3/4" Sharp - for Resinous Coatings - Extra-Large
46131	Replacement Spikes - 3/4" Sharp (Set of 32 - 16 Per Shoe)
46132	Replacement Spikes - 1" Rounded (Set of 32 - 16 Per Shoe)

Spiked Rollers

We manufacture our spikes and end caps out of solvent-resistant High-Density (HD) and Ultra-High Molecular Weight (UHMW) Polyethylene, respectively, for easier cleanup and extended wear. Spikes are available in 7/16", 9/16" and 13/16" lengths. These rollers also come in 36" and 48" widths which are preferred by some applicators when very large, flat areas need to be treated quickly. We also have 1-1/2" and 3" widths on special frames for very tight areas. Each of our 18" or wider rollers come with a heavy-duty aluminum frame, high-grade stainless steel axles, our superior gusset bracing and a maximum strength threaded handle adapter. Our 9" rollers come with either a special radial frame or a heavy-duty aluminum frame, both with a threaded handle adapter. The 1-1/2" and 3" rollers come on special handled frames. (Standard "paint-roller" frames do not work with our 9" spiked rollers).

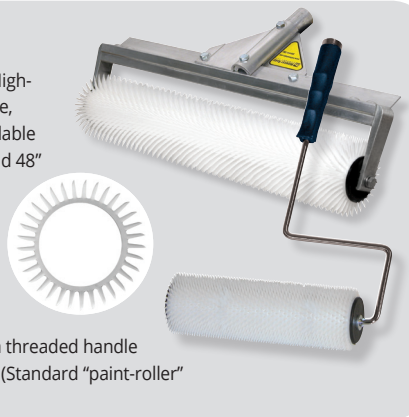

Handles

Powder-coated aluminum handles with milled aluminum threaded tips - for use with threaded handle adapters. We designed this milled threaded tip handle to provide the "tightest" fit with our tools that are available with our exclusive threaded handle adapter. These handles have a durable, milled threaded aluminum tip for added strength - no more broken tips - and come in 60", 66", and 82" lengths. We also have a 60" extension handle available to use with these handles which has a threaded milled aluminum tip on one end and a threaded milled aluminum receptacle on the other end.

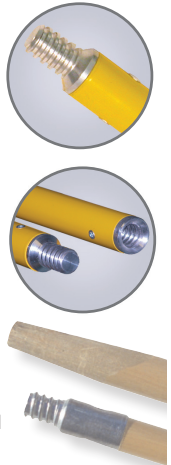

Hardwood Handles - We offer a variety of high quality hardwood handles, with either a tapered tip or a metal threaded tip.

Low Viscosity Mixers

- Pro-Grade mixers are the "choice" of many contractors
- Low shear for minimal air entrapment while mixing
- Quality powder-coated steel construction in 2 sizes
- 1-2 gallon paddle with 3-1/2" turbine style head on a 19-3/4" x 5/16" diameter hex shaft
- 2-5 gallon paddle with a 23-1/2" x 3/8" diameter hex shaft
- Ideal for lower viscosity materials

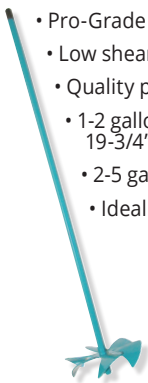

"Jiffy" Mixers are also available

Roller Covers & Frames

We offer a wide range of rollers, roller covers, and roller frames up to 36" in width. Our roller covers are available in single units or packs of 12. Roller cover nap lengths range from 1/4" to 3/4". Loop, mohair, synthetic, fabric, phenolic, "ribbed" and aluminum rollers are available. Special rollers are available for terrazzo applications. All rollers shown are solvent and shed-resistant.



9" & 18" Loop Roller

9" & 18" Mohair, 1/4" Nap Roller

9" - 36" Pro-Grade, 1/4" - 3/4" Nap Roller

9" & 18" Phenolic Roller

3" 6" & 9" Ribbed Rollers

Trowels

USA Made. Tempered, ground and polished high carbon spring steel. Blades are fastened with hardened steel rivets. Wooden handles for better gripping power. Selected by manufacturers' "technical specialists" for decorative concrete and floor coating applications.

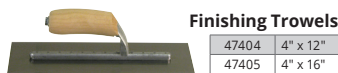

Finishing Trowels

47404	4" x 12"
47405	4" x 16"



Epoxy Mortar Trowels

47460	3" x 12"
47461	3" x 16"



Rounded End Trowels

47465	4" x 16"
47466	4" x 18"

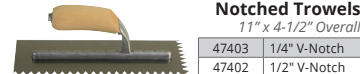

Notched Trowels

11" x 4-1/2" Overall	
47403	1/4" V-Notch
47402	1/2" V-Notch



Heavy-Duty Cove Trowel

High Carbon Blue Steel	
1" Radius	
47414	7-1/2" x 5-3/4" x 3-1/2"

Other cove trowel options are available

Flexible Radius Trowel

Rubber Blade

46010	6-1/2" x 9-1/2"
-------	-----------------

