



Senershield-R/-RS/-VB

A Systems Concrete / Masonry Incorporating
Fluid-Applied Vapor Permeable and
Impermeable Air/Water-Resistive Barriers

Typical Details

(THIS PAGE INTENTIONALLY LEFT BLANK)

Senershield-R/-RS/-VB

Typical Details

Concrete/Masonry Incorporating Fluid-Applied Vapor Permeable and Impermeable Air/Water-Resistive Barriers

Table of Contents

1. Typical Control or Expansion Joint
(Master Builders Solutions WS Flash Only)
2. Typical Control or Expansion Joint
(Backer Rod & Sealant Only)
3. Typical Control or Expansion Joint
(Master Builders Solutions WS Flash with
Backer Rod & Sealant)
4. Typical Rough Opening Treatment
5. Typical Penetration through Wall Construction
6. Typical Penetration through Wall Construction
(with Fabric Only)
7. Typical Rough Opening Treatment with Blocking and
Sheathing Fabric
8. Typical Rough Opening Treatment with Blocking and Master
Builders Solutions WS Flash
9. Typical Termination at Grade - Masonry Veneer
10. Typical EIFS Abutment to Brick with Continuous Insulation
11. Typical Termination at Foundation with Brick incorporating
Through Wall Flashing - Termination Bar
12. Typical Termination at Foundation with Brick incorporating
Through Wall Flashing - Master Builders Solutions WS Flash
13. Typical Inside Corner
14. Typical Outside Corner
15. Typical Inside Corner Change in Substrate
16. Typical Termination at Floorline-Brick Shelf Angle
17. Typical Through Wall Flashing at Head
18. Typical Window Jamb
19. Typical Window Head
20. Typical Window Sill
21. Typical Roof Edge or Parapet Cap Flashing

Notes:

- **Install Master Builders Solutions materials in accordance with current installation instructions.**
- **Unsatisfactory conditions shall be reported to the General Contractor and corrected before the application of Master Builders Solutions products.**
- **The details within represent Master Builders Solutions Construction Systems US, LLC (hereinafter Master Builders Solutions) latest recommendations. They are presented in good faith by Master Builders Solutions. The details are subject to change without notice. Master Builders Solutions accepts no liability for the end use of the details. For conditions not shown, consult Master Builders Solutions for review of specific detail.**

(THIS PAGE INTENTIONALLY LEFT BLANK)

Senershield-R/-RS/-VB

TYPICAL CONTROL OR EXPANSION JOINT (MASTER BUILDERS SOLUTIONS WS FLASH ONLY)

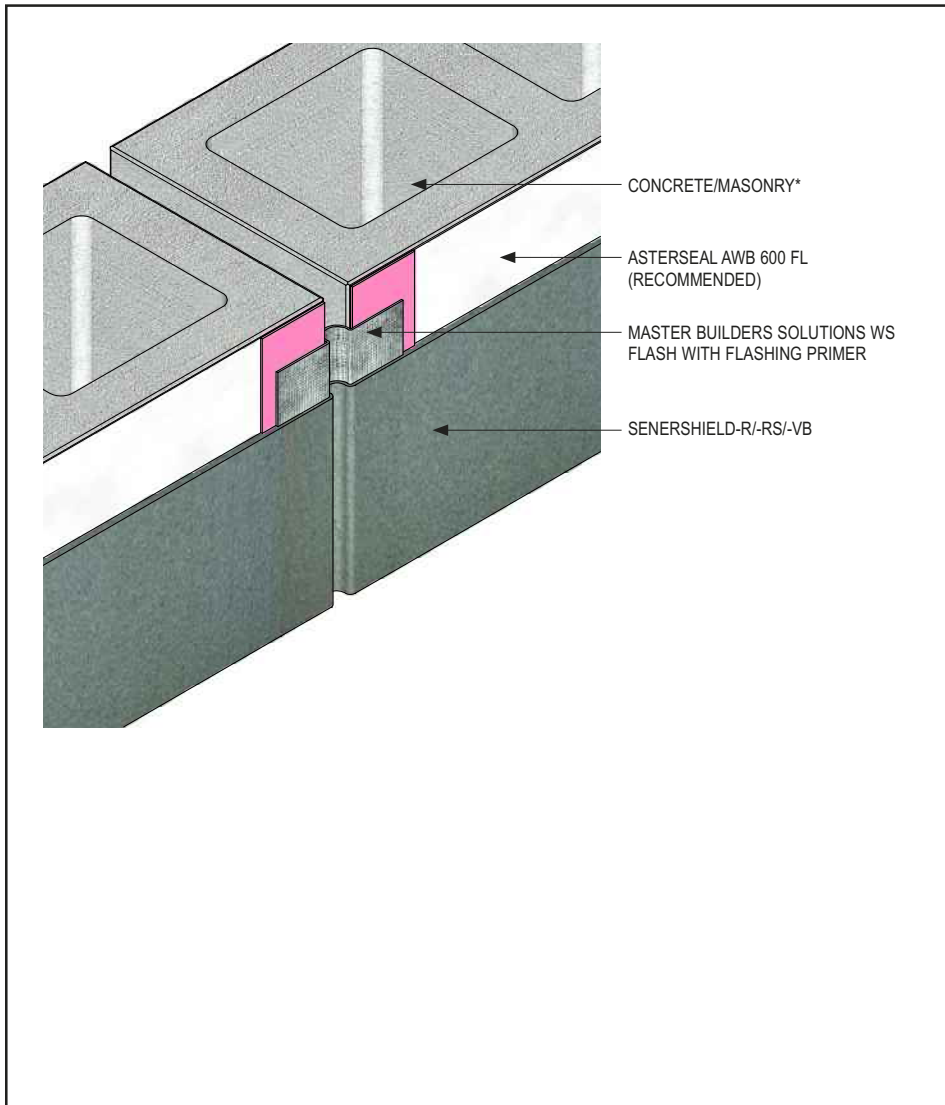

- Install Master Builders Solutions materials in accordance with current installation instructions.
- Unsatisfactory conditions shall be reported to the General Contractor and corrected before the application of Master Builders Solutions products.

CMU-01 2108

(*NOTE: BY OTHERS)

This detail represents Master Builders Solutions Construction Systems US, LLC (hereinafter Master Builders Solutions) latest recommendations. It is presented in good faith by Master Builders Solutions. The detail is subject to change without notice. Master Builders Solutions accepts no liability for the end use of the detail. For conditions not shown, consult Master Builders Solutions for review of specific detail.

Senershield-R/-RS/-VB

TYPICAL CONTROL OR EXPANSION JOINT (BACKER ROD & SEALANT ONLY)

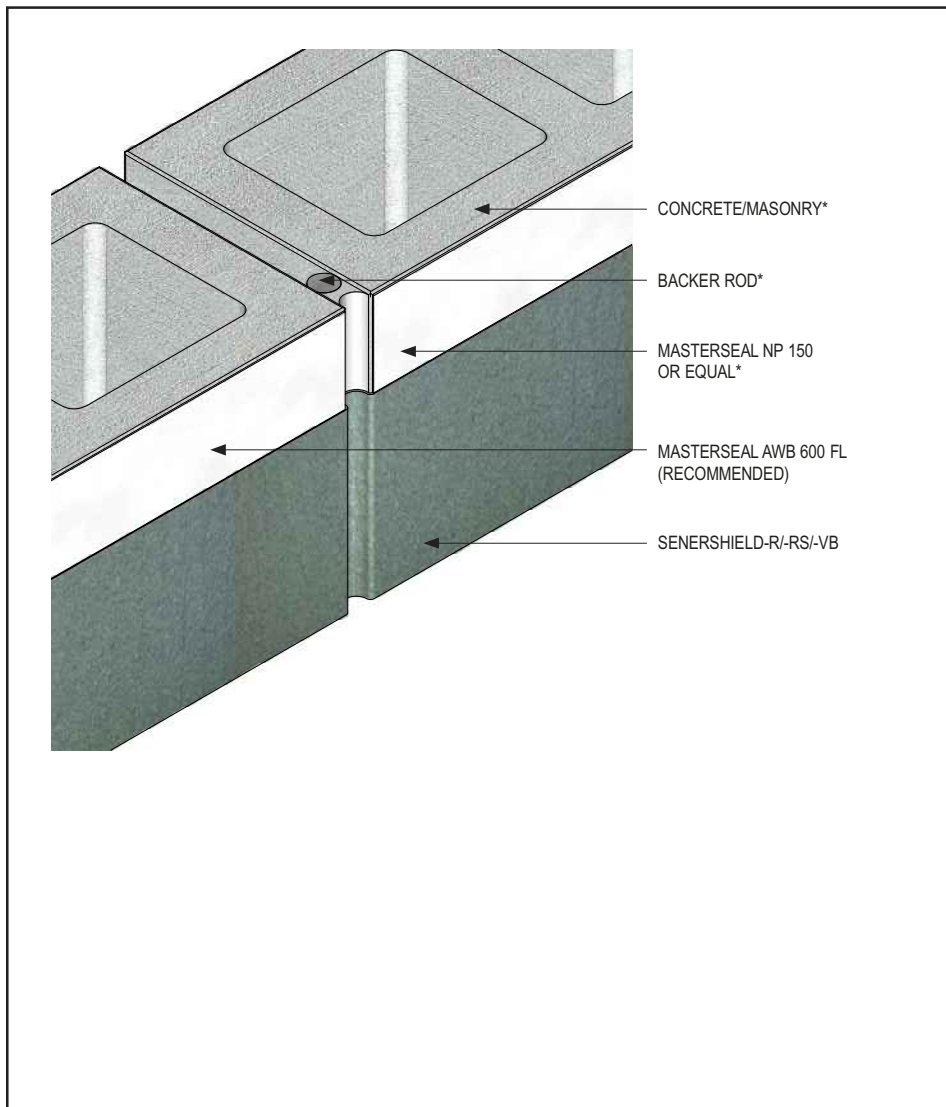

- Install Master Builders Solutions materials in accordance with current installation instructions.
- Unsatisfactory conditions shall be reported to the General Contractor and corrected before the application of Master Builders Solutions products.
- Senershield-R/-RS/-VB is not required on sealant joint.

CMU-02 2108

(*NOTE: BY OTHERS)

This detail represents Master Builders Solutions Construction Systems US, LLC (hereinafter Master Builders Solutions) latest recommendations. It is presented in good faith by Master Builders Solutions. The detail is subject to change without notice. Master Builders Solutions accepts no liability for the end use of the detail. For conditions not shown, consult Master Builders Solutions for review of specific detail.

Senershield-R/-RS/-VB

TYPICAL CONTROL OR EXPANSION JOINT (MASTER BUILDERS SOLUTIONS WS FLASH WITH BACKER ROD & SEALANT)

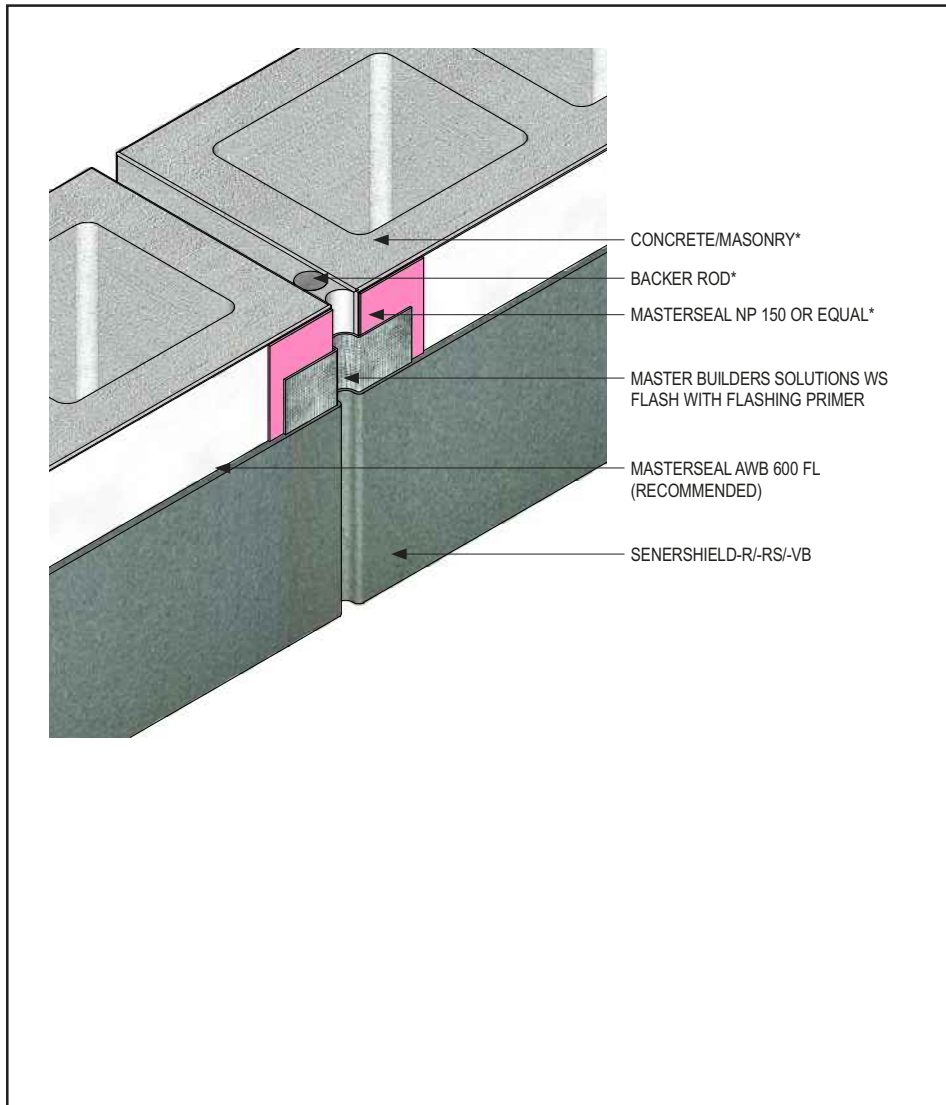

- Install Master Builders Solutions materials in accordance with current installation instructions.
- Unsatisfactory conditions shall be reported to the General Contractor and corrected before the application of Master Builders Solutions products.

CMU-03 2108

(*NOTE: BY OTHERS)

This detail represents Master Builders Solutions Construction Systems US, LLC (hereinafter Master Builders Solutions) latest recommendations. It is presented in good faith by Master Builders Solutions. The detail is subject to change without notice. Master Builders Solutions accepts no liability for the end use of the detail. For conditions not shown, consult Master Builders Solutions for review of specific detail.

Senershield-R/-RS/-VB

TYPICAL ROUGH OPENING TREATMENT

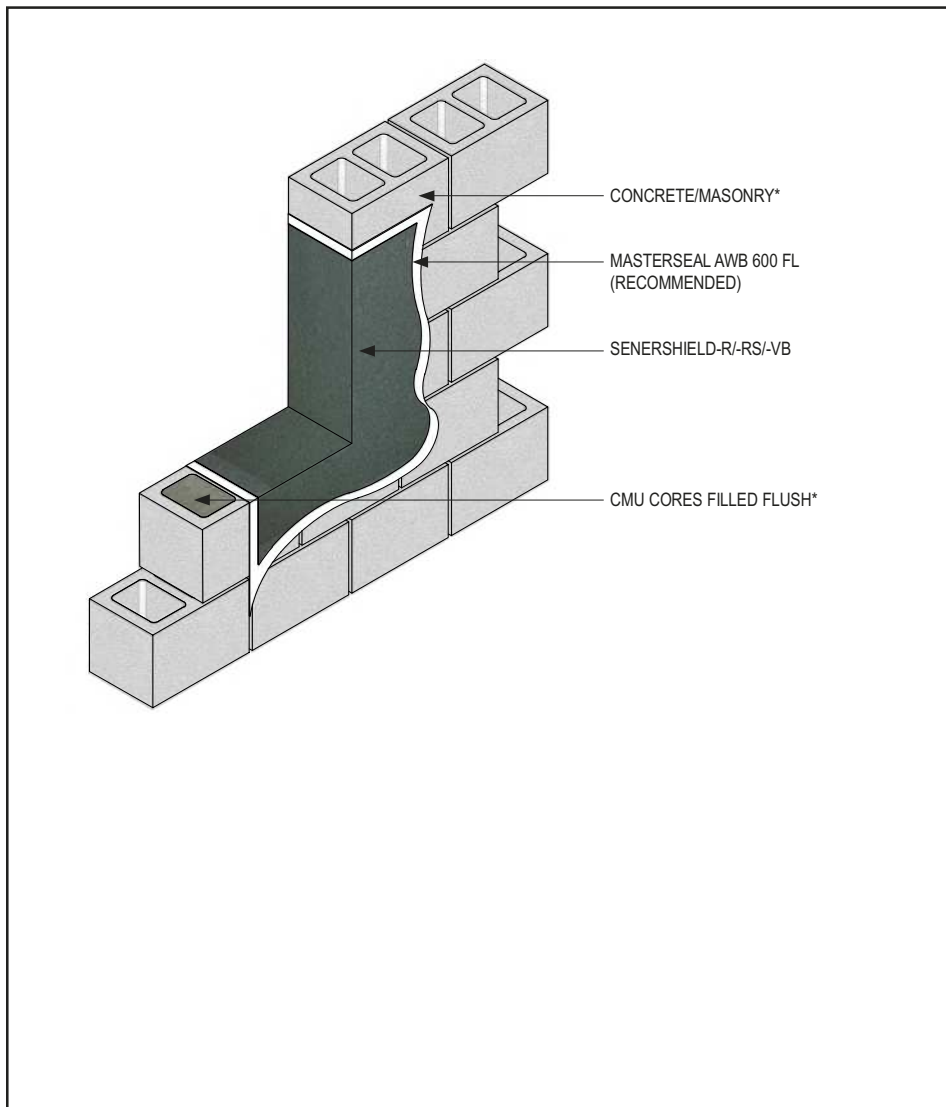

- Install Master Builders Solutions materials in accordance with current installation instructions.
- Unsatisfactory conditions shall be reported to the General Contractor and corrected before the application of Master Builders Solutions products.
- Ensure continuity of air/water-resistive barrier is maintained.
- Ensure a pinhole-free application of Senershield-R/-RS/-VB is achieved.
- Sheathing Fabric or Master Builders Solutions WS Flash application is optional at rough opening.
- For more information, reference the *Senergy Application Guidelines for Flashing Rough Openings on Concrete and Masonry* technical bulletin.

CMU-04 2108

(*NOTE: BY OTHERS)

This detail represents Master Builders Solutions Construction Systems US, LLC (hereinafter Master Builders Solutions) latest recommendations. It is presented in good faith by Master Builders Solutions. The detail is subject to change without notice. Master Builders Solutions accepts no liability for the end use of the detail. For conditions not shown, consult Master Builders Solutions for review of specific detail.

Senershield-R/-RS/-VB

TYPICAL PENETRATION THROUGH WALL CONSTRUCTION

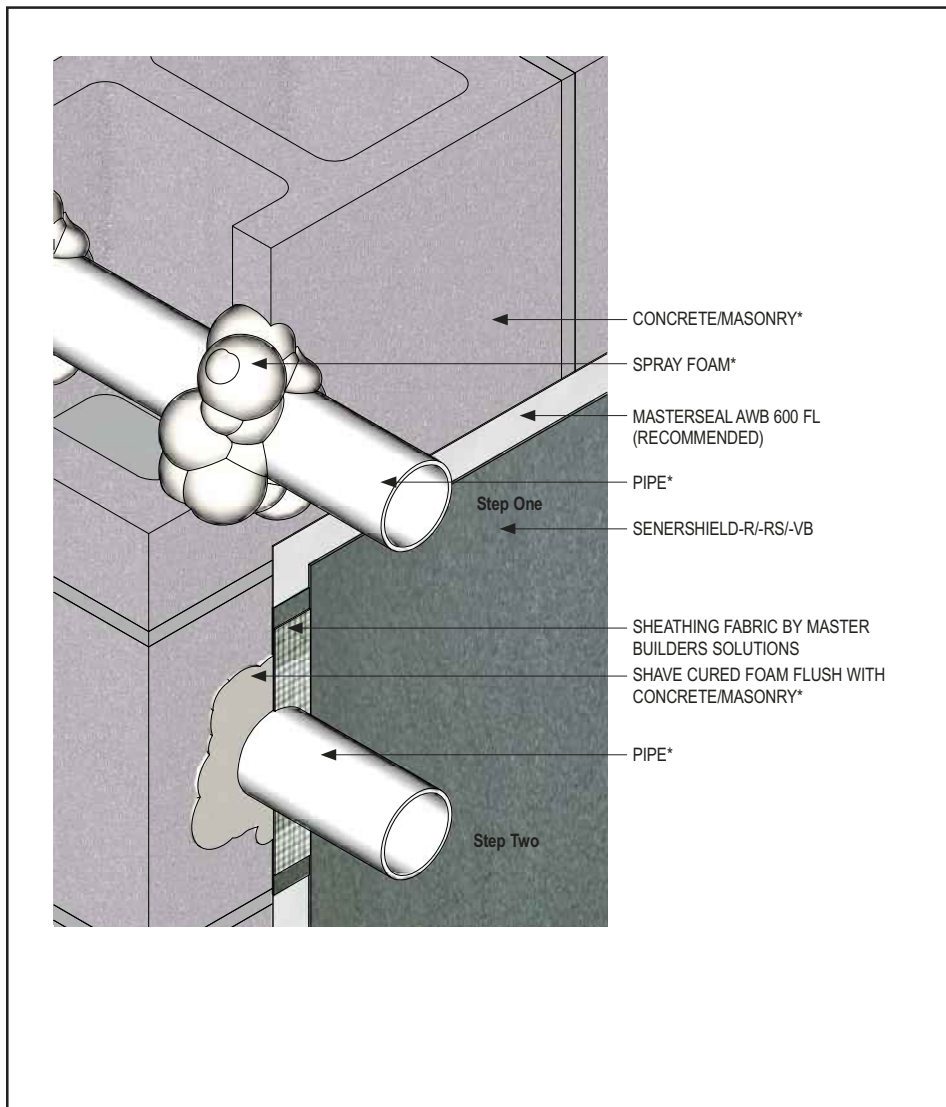

- Install Master Builders Solutions materials in accordance with current installation instructions.
- Unsatisfactory conditions shall be reported to the General Contractor and corrected before the application of Master Builders Solutions products.
- Ensure spray foam is low expansion.
- Embed Sheathing Fabric in Senershield-R/-RS/-VB.

CMU-05 2108

(*NOTE: BY OTHERS)

This detail represents Master Builders Solutions Construction Systems US, LLC (hereinafter Master Builders Solutions) latest recommendations. It is presented in good faith by Master Builders Solutions. The detail is subject to change without notice. Master Builders Solutions accepts no liability for the end use of the detail. For conditions not shown, consult Master Builders Solutions for review of specific detail.

Senershield-R/-RS/-VB

TYPICAL PENETRATION THROUGH WALL CONSTRUCTION (FABRIC ONLY)

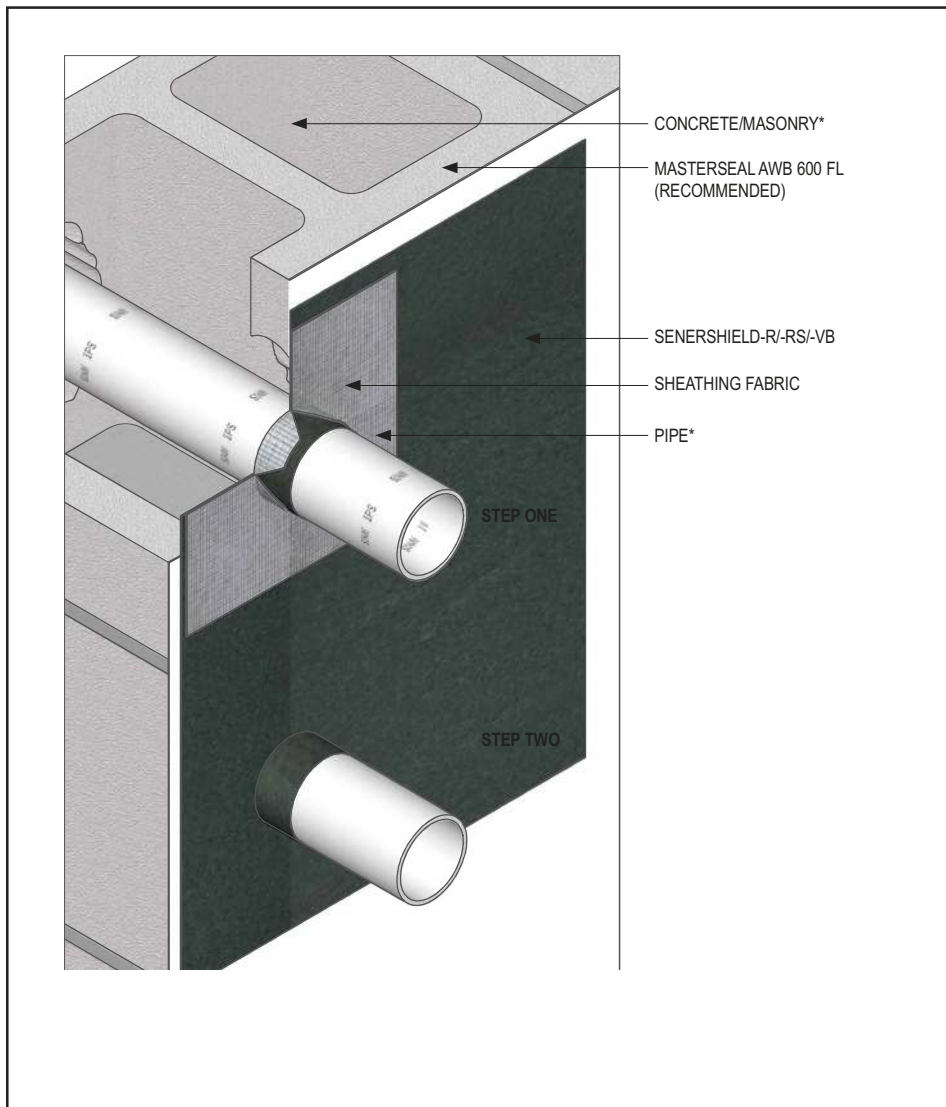

- Install Master Builders Solutions materials in accordance with current installation instructions.
- Unsatisfactory conditions shall be reported to the General Contractor and corrected before the application of Master Builders Solutions products.
- Cut a square piece of Sheathing Fabric large enough to extend past the pipe by 2" in each direction.
- At the center of the square piece of Sheathing Fabric, pierce a small hole with a blade or scissors.
- With a blade or scissors, cut an "X". Turn the square about 45° and cut another X. The center point of both "X"s will be the point you pierced previously.
- Insert the pipe through the newly cut square so it is centered with a minimum of 2" on each side with the cut flaps point outward. The square should be flush with the Concrete/Masonry, See Step 1.
- Embed the Sheathing Fabric in Senershield-R/-RS/-VB and coat the flaps around the pipe, See Step 2.
- Wrap a 1" strip of Sheathing Fabric embedded in Senershield-R/-RS/-VB around the flaps.

CMU-06 2108

(*NOTE: BY OTHERS)

This detail represents Master Builders Solutions Construction Systems US, LLC (hereinafter Master Builders Solutions) latest recommendations. It is presented in good faith by Master Builders Solutions. The detail is subject to change without notice. Master Builders Solutions accepts no liability for the end use of the detail. For conditions not shown, consult Master Builders Solutions for review of specific detail.

Senershield-R/-RS/-VB

TYPICAL ROUGH OPENING TREATMENT WITH BLOCKING AND SHEATHING FABRIC

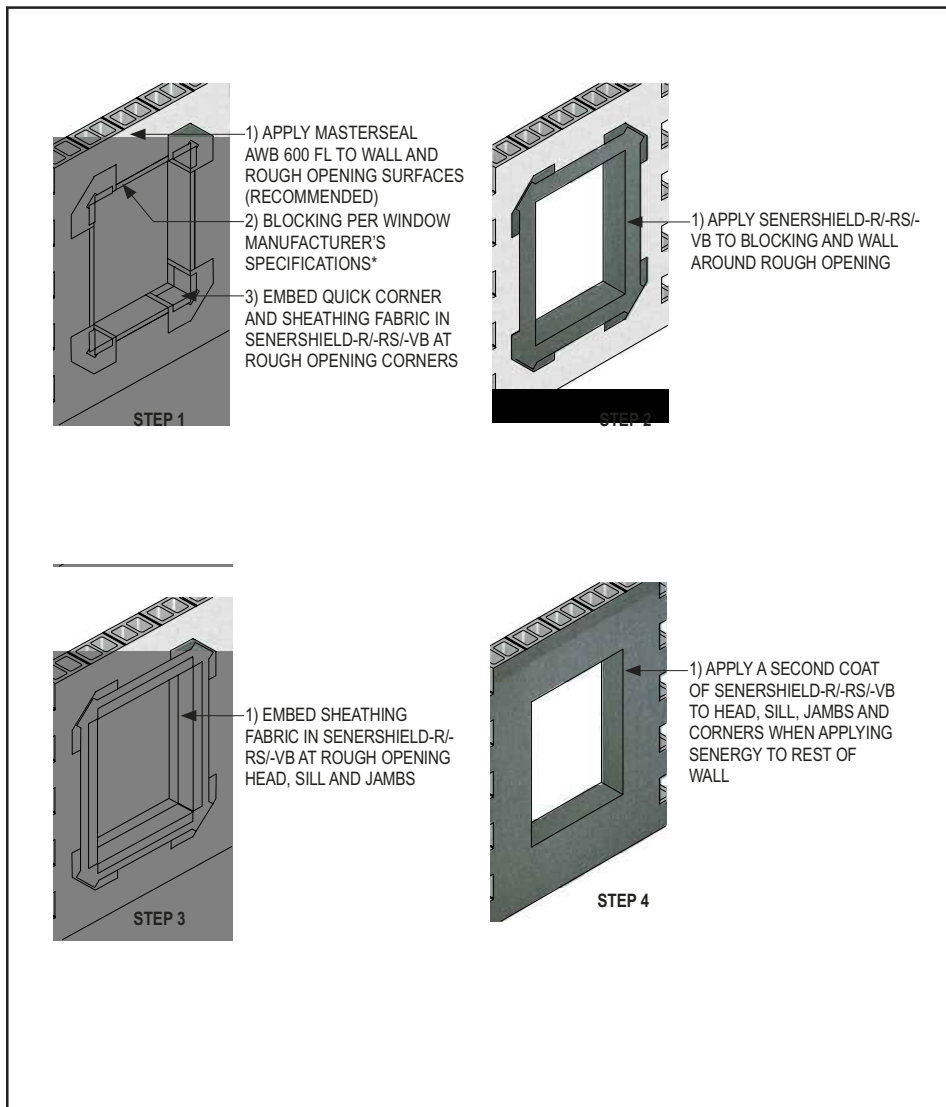

- Recessed or protruding wood bucks require special consideration.
- Ensure all blocking joints receive a full treatment of Senergy and Sheathing Fabric.
- For more information, reference the Senergy Application Guidelines for Flashing Rough Openings on Concrete and Masonry technical bulletin.

CMU-09 2108

(*NOTE: BY OTHERS)

This detail represents Master Builders Solutions Construction Systems US, LLC (hereinafter Master Builders Solutions) latest recommendations. It is presented in good faith by Master Builders Solutions. The detail is subject to change without notice. Master Builders Solutions accepts no liability for the end use of the detail. For conditions not shown, consult Master Builders Solutions for review of specific detail.

Senershield-R/-RS/-VB

TYPICAL ROUGH OPENING TREATMENT WITH BLOCKING AND MASTER BUILDERS SOLUTIONS WS FLASH

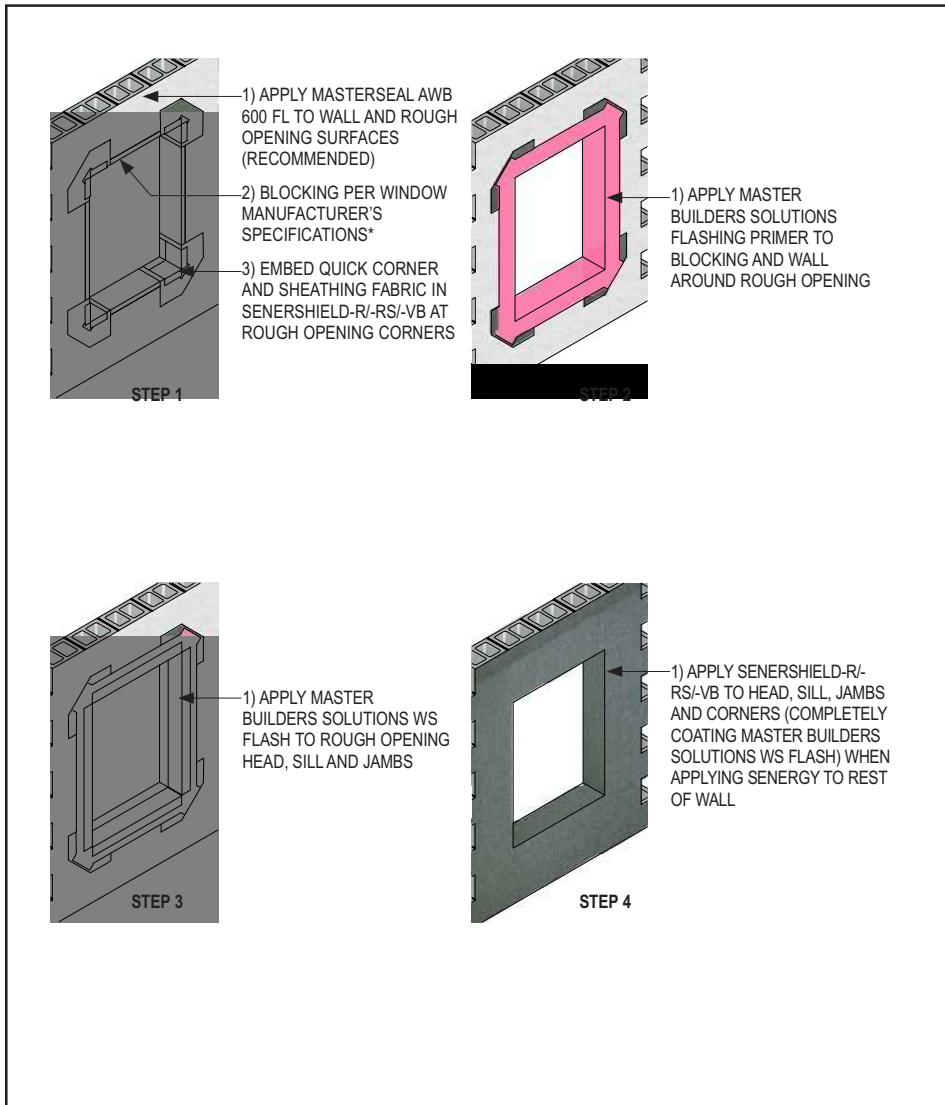

- Recessed or protruding wood bucks require special consideration.
- Ensure all blocking joints receive a full treatment of Senergy and Sheathing Fabric.
- For more information, reference the Senergy Application Guidelines for Flashing Rough Openings on Concrete and Masonry technical bulletin.

CMU-10 2108

(*NOTE: BY OTHERS)

This detail represents Master Builders Solutions Construction Systems US, LLC (hereinafter Master Builders Solutions) latest recommendations. It is presented in good faith by Master Builders Solutions. The detail is subject to change without notice. Master Builders Solutions accepts no liability for the end use of the detail. For conditions not shown, consult Master Builders Solutions for review of specific detail.

Senershield-R/-RS/-VB

TYPICAL TERMINATION AT GRADE-MASONRY VENEER

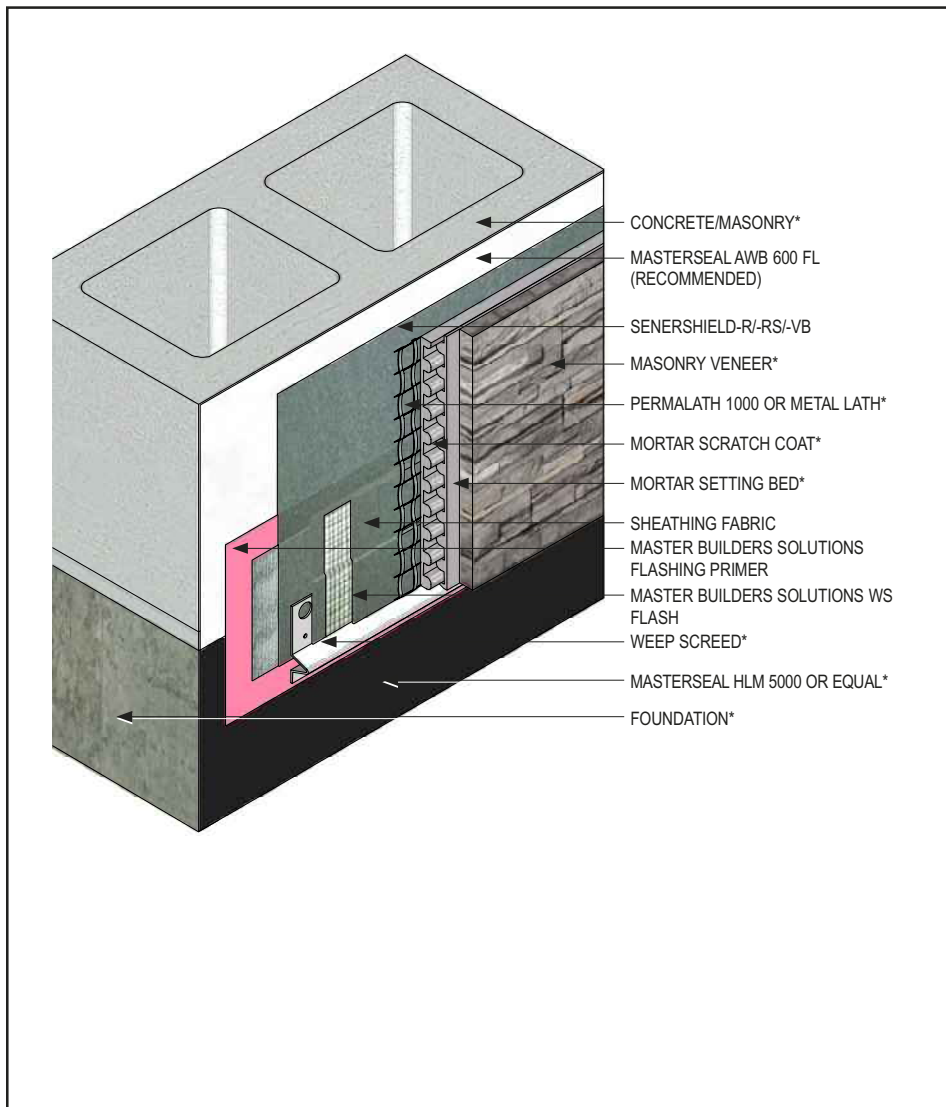

- Install Master Builders Solutions materials in accordance with current installation instructions.
- Unsatisfactory conditions shall be reported to the General Contractor and corrected before the application of Master Builders Solutions products.
- Embed Sheathing Fabric in Senershield-R/-RS/-VB.
- Paper backed lath can be used in lieu of slip sheet.

CMU-11 2108

(*NOTE: BY OTHERS)

This detail represents Master Builders Solutions Construction Systems US, LLC (hereinafter Master Builders Solutions) latest recommendations. It is presented in good faith by Master Builders Solutions. The detail is subject to change without notice. Master Builders Solutions accepts no liability for the end use of the detail. For conditions not shown, consult Master Builders Solutions for review of specific detail.

Senershield-R/-RS/-VB

TYPICAL EIFS ABUTMENT TO BRICK WITH CONTINUOUS INSULATION

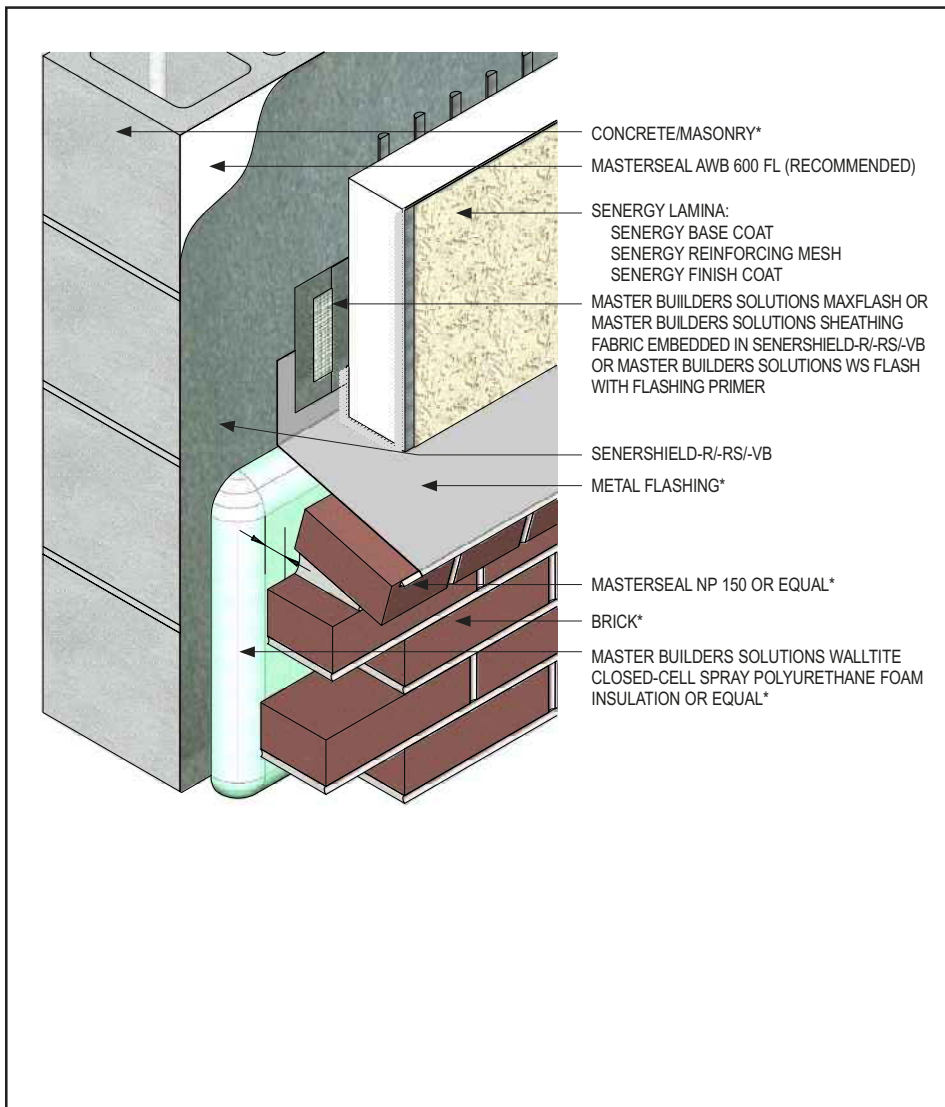

- Install Master Builders Solutions materials in accordance with current installation instructions.
- Unsatisfactory conditions shall be reported to the General Contractor and corrected before the application of Master Builders Solutions products.
- Embed Sheathing Fabric in Senershield-R/-RS/-VB.
- Up to 12" of EPS thickness can be used with Master Builders Solutions EIFS.

CMU-12 2108

(*NOTE: BY OTHERS)

This detail represents Master Builders Solutions Construction Systems US, LLC (hereinafter Master Builders Solutions) latest recommendations. It is presented in good faith by Master Builders Solutions. The detail is subject to change without notice. Master Builders Solutions accepts no liability for the end use of the detail. For conditions not shown, consult Master Builders Solutions for review of specific detail.

Senershield-R/-RS/-VB

TYPICAL TERMINATION AT FOUNDATION WITH BRICK INCORPORATING TWF - TERMINATION BAR

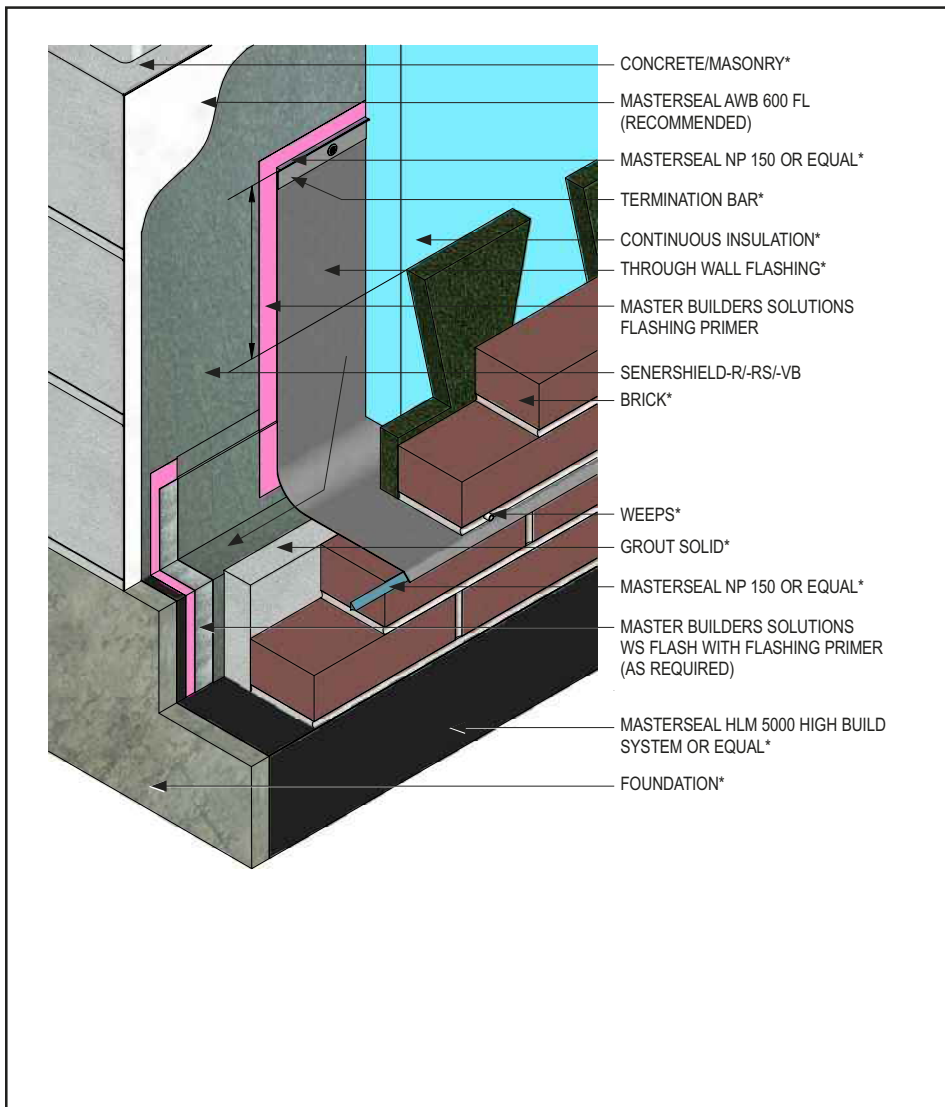

- Install Master Builders Solutions materials in accordance with current installation instructions.
- Unsatisfactory conditions shall be reported to the General Contractor and corrected before the application of Master Builders Solutions products.
- Air space between masonry /concrete and brick per design (not shown).
- Extend Through Wall Flashing vertically up the wall to 8" (203 mm) minimum height.

CMU-13 2108

(*NOTE: BY OTHERS)

This detail represents Master Builders Solutions Construction Systems US, LLC (hereinafter Master Builders Solutions) latest recommendations. It is presented in good faith by Master Builders Solutions. The detail is subject to change without notice. Master Builders Solutions accepts no liability for the end use of the detail. For conditions not shown, consult Master Builders Solutions for review of specific detail.

Senershield-R/-RS/-VB

TYPICAL TERMINATION AT FOUNDATION WITH BRICK INCORPORATING TWF - MASTER BUILDERS SOLUTIONS WS FLASH

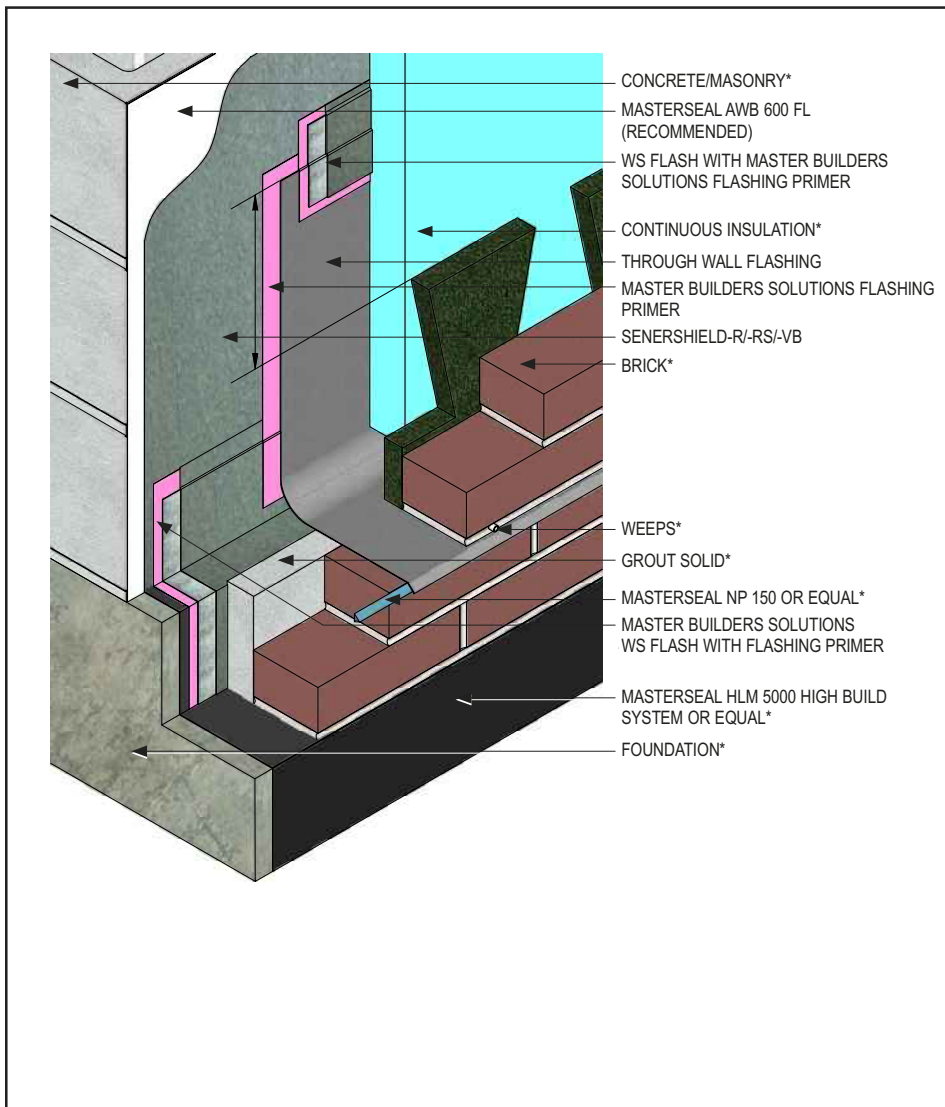

- Install Master Builders Solutions materials in accordance with current installation instructions.
- Unsatisfactory conditions shall be reported to the General Contractor and corrected before the application of Master Builders Solutions products.
- Air space between masonry /concrete and brick per design (not shown).
- Extend Through Wall Flashing vertically up the wall to 203 mm (8") minimum height.

CMU-14 2108

(*NOTE: BY OTHERS)

This detail represents Master Builders Solutions Construction Systems US, LLC (hereinafter Master Builders Solutions) latest recommendations. It is presented in good faith by Master Builders Solutions. The detail is subject to change without notice. Master Builders Solutions accepts no liability for the end use of the detail. For conditions not shown, consult Master Builders Solutions for review of specific detail.

Senershield-R/-RS/-VB

TYPICAL INSIDE CORNER

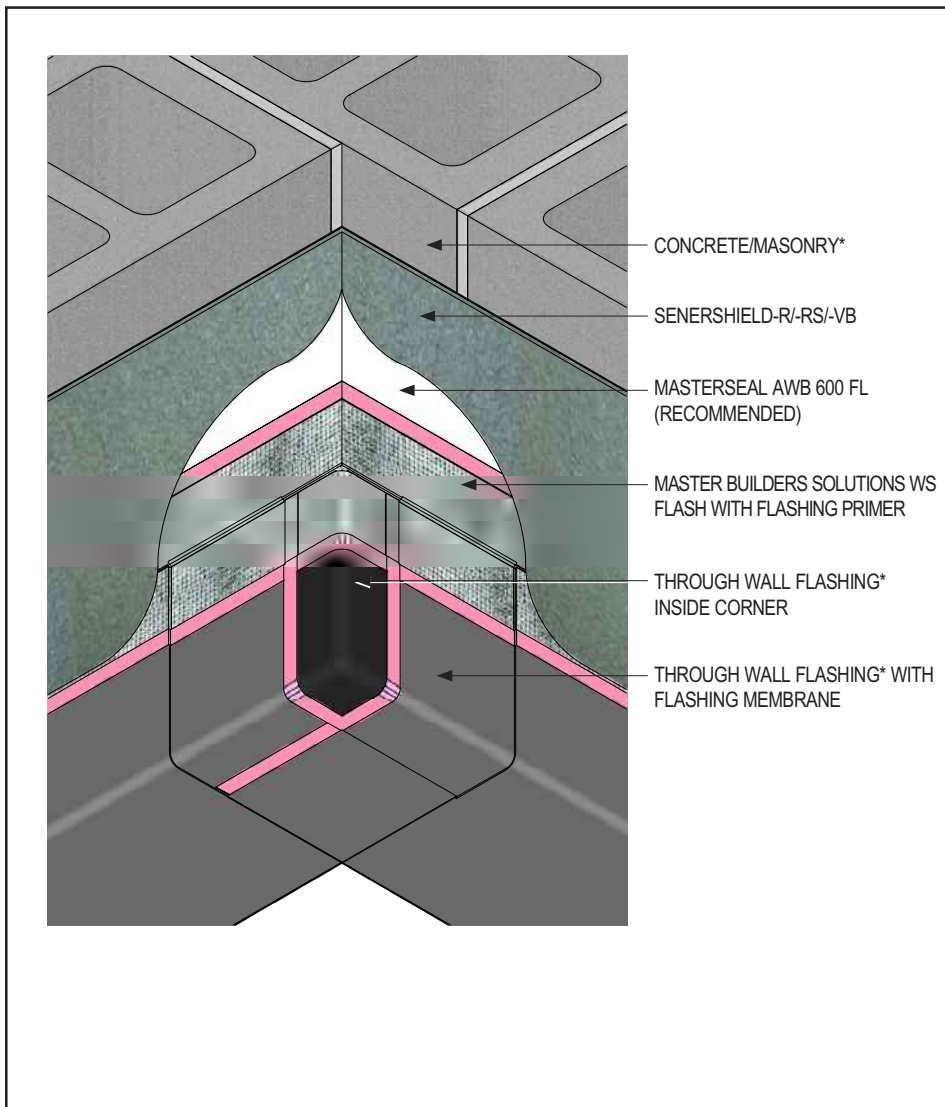

- Install Master Builders Solutions materials in accordance with current installation instructions.
- Unsatisfactory conditions shall be reported to the General Contractor and corrected before the application of Master Builders Solutions products.
- Set Master Builders Solutions WS Flash Inside Corner in MasterSeal NP 150 Sealant.
- Lap Through Wall Flashing at least 2" onto Inside Corner.
- Apply a bead of MasterSeal NP 150 sealant between Through Wall Flashing and Inside Corner to create an airtight and watertight seal.
- A termination bar and MasterSeal NP 150 sealant can be used instead of Master Builders Solutions WS Flash (See AWRB-CMU-11).
- Center Master Builders Solutions WS Flash so half of the width covers Through Wall Flashing and half covers the CMU substrate.

Visit the Senergy website (senergy.master-builders-solutions.com/en) for a four step expanded version of this detail.

CMU-15 2108

(*NOTE: BY OTHERS)

This detail represents Master Builders Solutions Construction Systems US, LLC (hereinafter Master Builders Solutions) latest recommendations. It is presented in good faith by Master Builders Solutions. The detail is subject to change without notice. Master Builders Solutions accepts no liability for the end use of the detail. For conditions not shown, consult Master Builders Solutions for review of specific detail.

Senershield-R/-RS/-VB

TYPICAL OUTSIDE CORNER

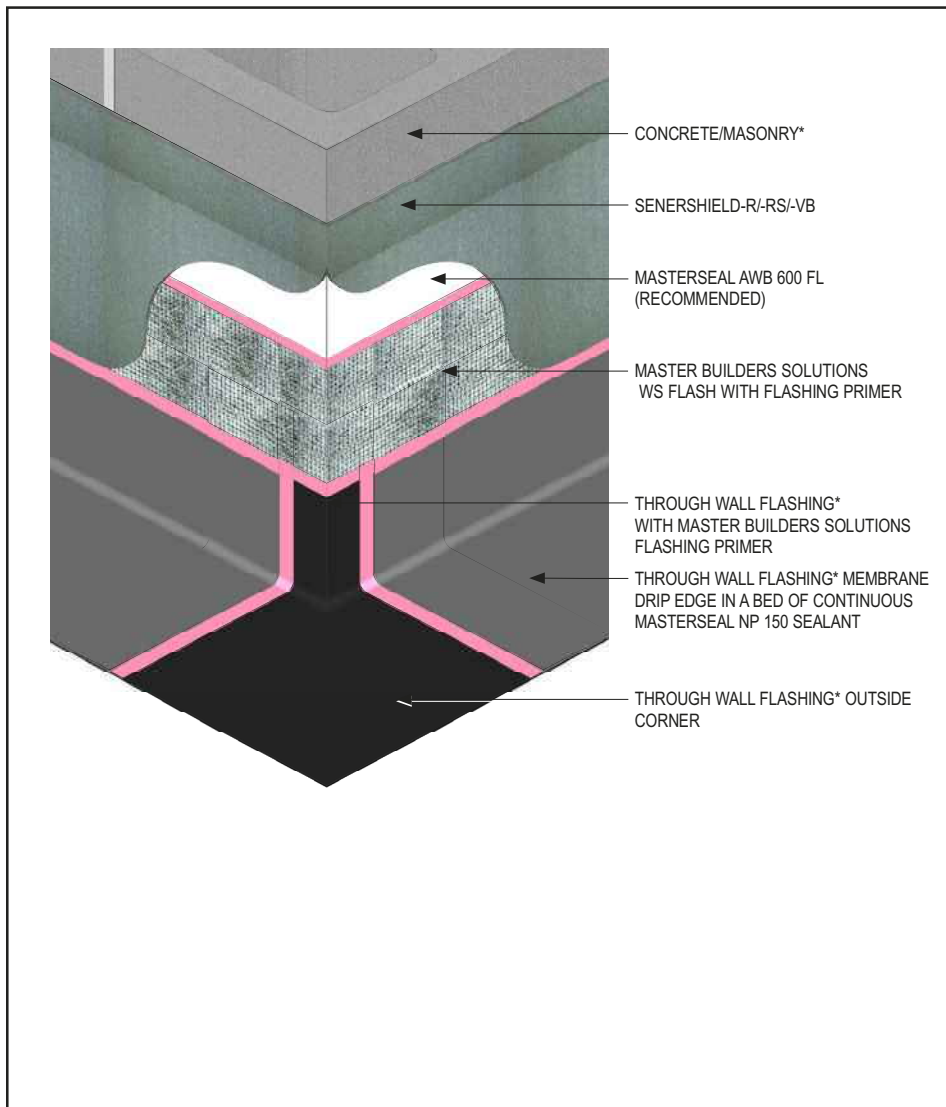

- Install Master Builders Solutions materials in accordance with current installation instructions.
- Unsatisfactory conditions shall be reported to the General Contractor and corrected before the application of Master Builders Solutions products.
- Set Through Wall Flashing Outside Corner in MasterSeal NP 150 Sealant.
- Extend Through Wall Flashing vertically up the wall 8" (not to scale).
- Apply a bead of MasterSeal NP 150 sealant between Through Wall Flashing and Outside Corner to create an airtight and watertight seal.
- Through Wall Flashing can be installed over MasterSeal AWB 600 FL (shown) or Senershield-R/-RS/-VB.
- Center Master Builders Solutions WS Flash so half of the width covers Through Wall Flashing and half covers the gypsum sheathing.
- Lap Through Wall Flashing a minimum of 2" over Outside Corner.

Visit the Senergy website (senergy.master-builders-solutions.com/en) for a four step expanded version of this detail.

CMU-16 2108

(*NOTE: BY OTHERS)

This detail represents Master Builders Solutions Construction Systems US, LLC (hereinafter Master Builders Solutions) latest recommendations. It is presented in good faith by Master Builders Solutions. The detail is subject to change without notice. Master Builders Solutions accepts no liability for the end use of the detail. For conditions not shown, consult Master Builders Solutions for review of specific detail.

Senershield-R/-RS/-VB

TYPICAL INSIDE CORNER CHANGE IN SUBSTRATE

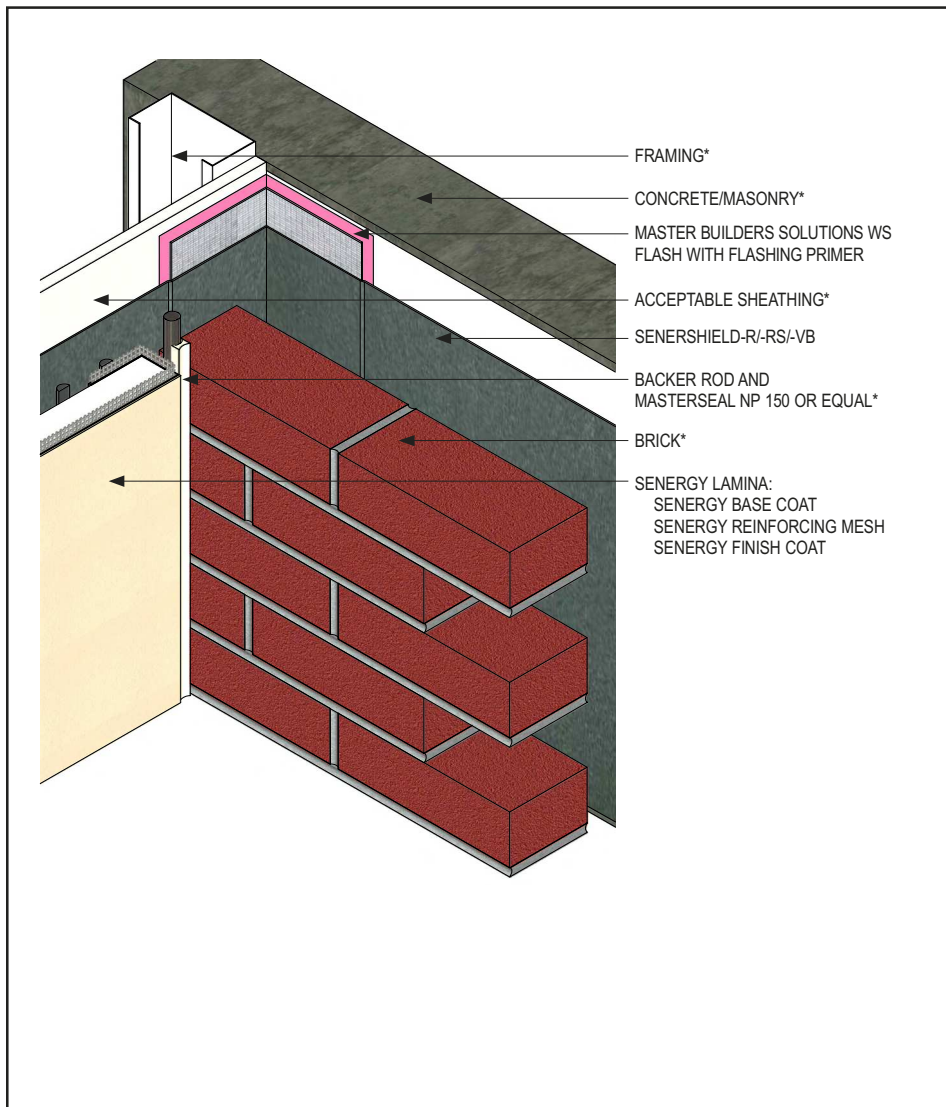

- Install Master Builders Solutions materials in accordance with current installation instructions.
- Unsatisfactory conditions shall be reported to the General Contractor and corrected before the application of Master Builders Solutions products.

CMU-17 2108

(*NOTE: BY OTHERS)

This detail represents Master Builders Solutions Construction Systems US, LLC (hereinafter Master Builders Solutions) latest recommendations. It is presented in good faith by Master Builders Solutions. The detail is subject to change without notice. Master Builders Solutions accepts no liability for the end use of the detail. For conditions not shown, consult Master Builders Solutions for review of specific detail.

Senershield-R/-RS/-VB

TYPICAL TERMINATION AT FLOORLINE- BRICK SHELF ANGLE

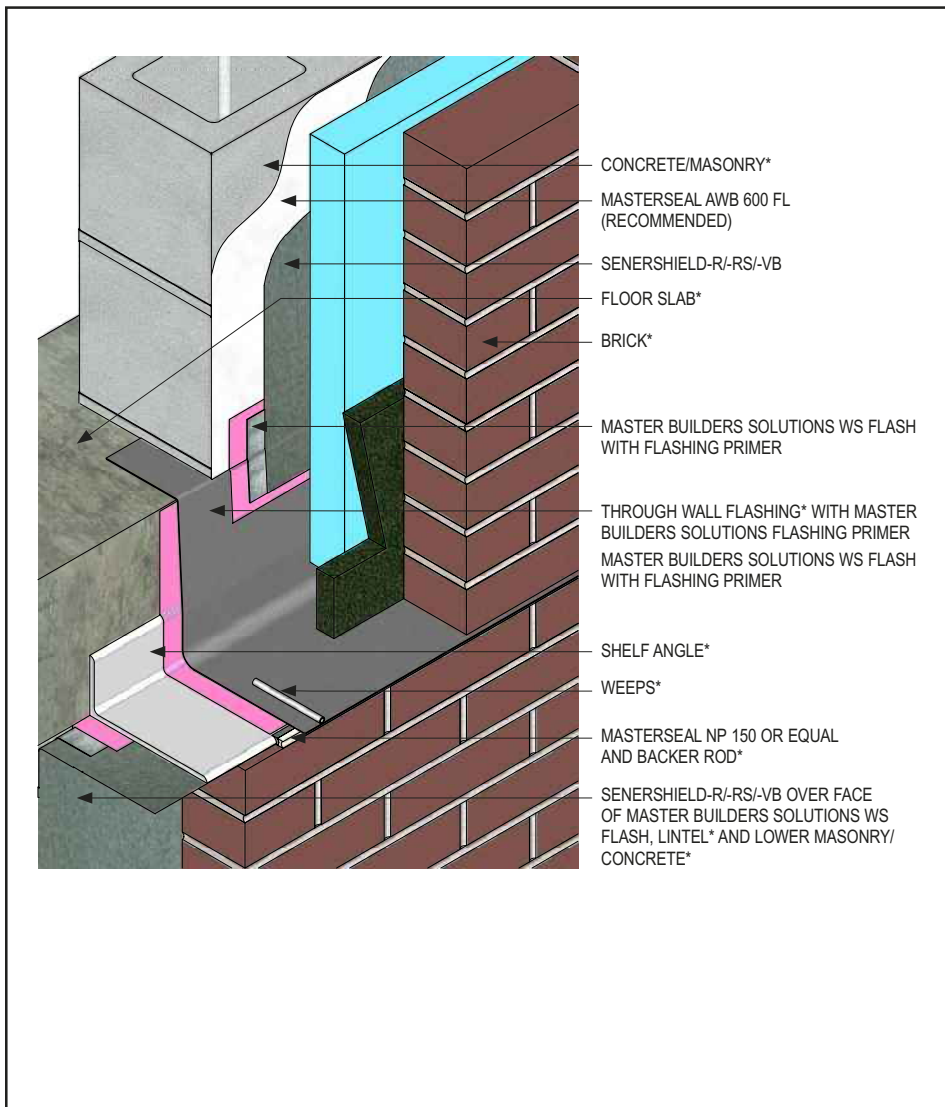

- Install Master Builders Solutions materials in accordance with current installation instructions.
- Unsatisfactory conditions shall be reported to the General Contractor and corrected before the application of Master Builders Solutions products.
- Air space between masonry /concrete and brick per design (not shown).
- Do not apply Through Wall Flashing to uncoated block; Senershield-R/-RS/-VB or Master Builders Solutions WS Block Filler are acceptable.
- Protect Through Wall Flashing from overspray.

CMU-18 2108

(*NOTE: BY OTHERS)

This detail represents Master Builders Solutions Construction Systems US, LLC (hereinafter Master Builders Solutions) latest recommendations. It is presented in good faith by Master Builders Solutions. The detail is subject to change without notice. Master Builders Solutions accepts no liability for the end use of the detail. For conditions not shown, consult Master Builders Solutions for review of specific detail.

Senershield-R/-RS/-VB

TYPICAL THROUGH WALL FLASHING AT HEAD

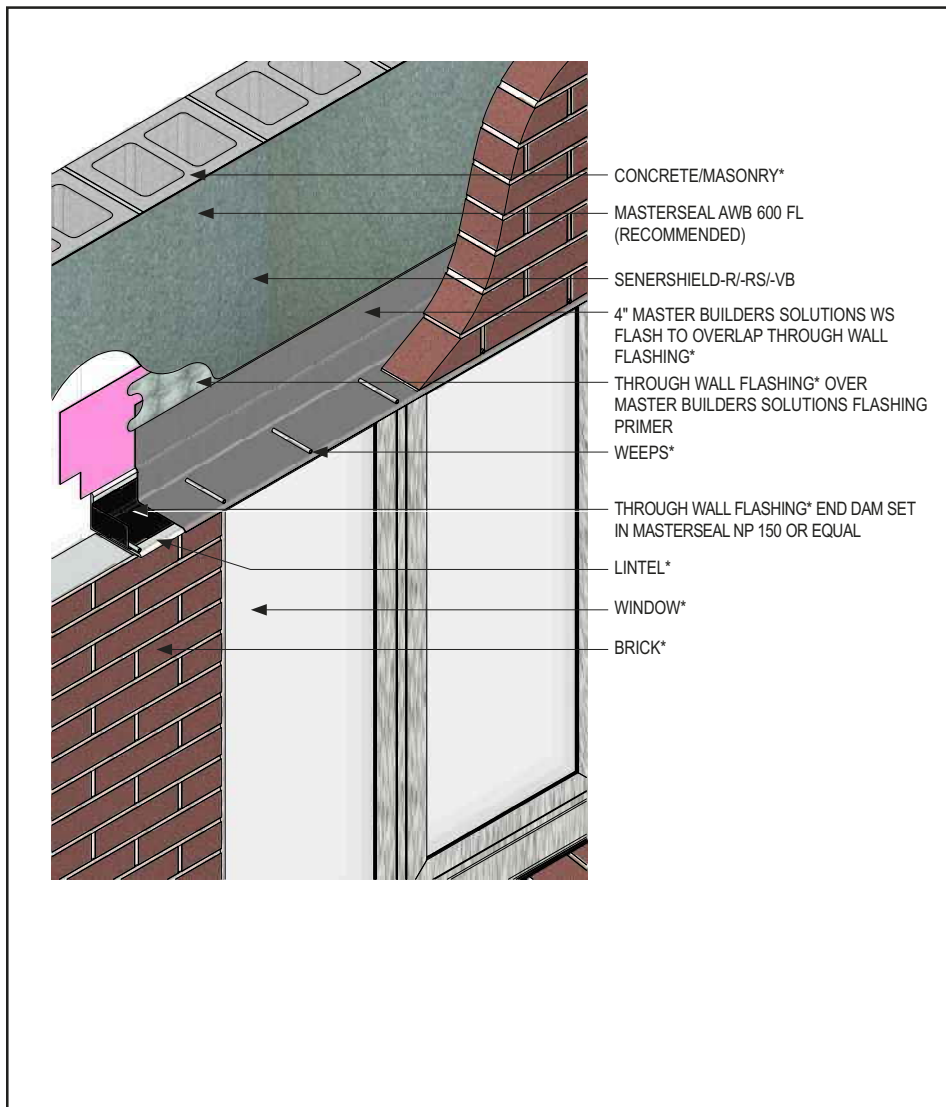

- Install Master Builders Solutions materials in accordance with current installation instructions.
- Unsatisfactory conditions shall be reported to the General Contractor and corrected before the application of Master Builders Solutions products.
- Air space between masonry /concrete and brick per design.
- Center Master Builders Solutions WS Flash so half of the width covers Through Wall Flashing and half covers the primed substrate.
- Through Wall Flashing can be folded to create an end dam. Ensure that seams are sealed with MasterSeal NP 150.
- If Senershield-R/-RS/-VB is applied before Through Wall Flashing, use Master Builders Solutions WS Flash and Senershield-R/-RS/-VB to seal the top edge.

Visit the Senergy website (senergy.master-builders-solutions.com/en) for a four step expanded version of this detail.

CMU-19 2108

(*NOTE: BY OTHERS)

This detail represents Master Builders Solutions Construction Systems US, LLC (hereinafter Master Builders Solutions) latest recommendations. It is presented in good faith by Master Builders Solutions. The detail is subject to change without notice. Master Builders Solutions accepts no liability for the end use of the detail. For conditions not shown, consult Master Builders Solutions for review of specific detail.

Senershield-R/-RS/-VB

TYPICAL WINDOW JAMB

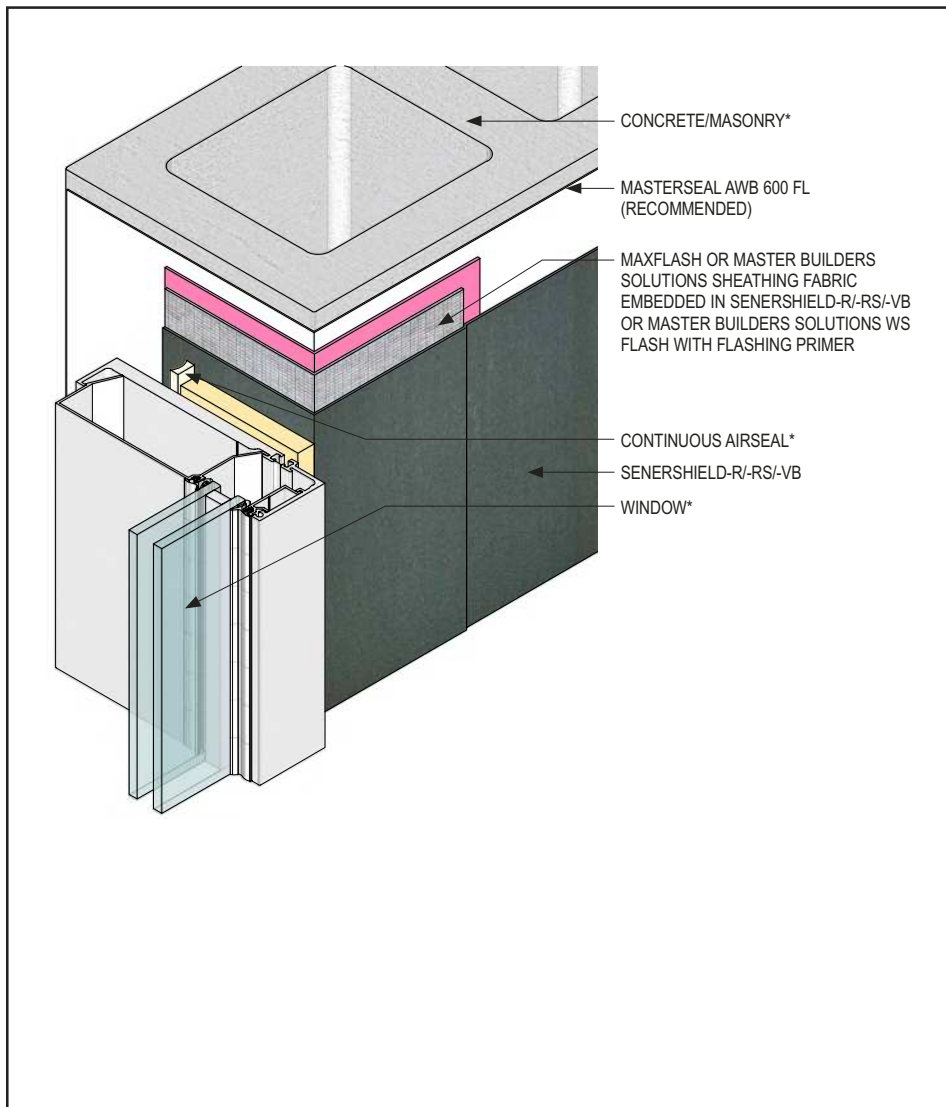

- Install Master Builders Solutions materials in accordance with current installation instructions.
- Unsatisfactory conditions shall be reported to the General Contractor and corrected before the application of Master Builders Solutions products.
- If blocking is installed prior to Senergy-HP / Senergy-I application, it shall be treated as a rough opening; verify adhesion before proceeding.
- Either Master Builders Solutions WS Flash with Flashing Primer or Sheathing Fabric can be used. See AWRB-CMU-04, AWRB-CMU-07 and AWRB-CMU-08.

CMU-20 2108

(*NOTE: BY OTHERS)

This detail represents Master Builders Solutions Construction Systems US, LLC (hereinafter Master Builders Solutions) latest recommendations. It is presented in good faith by Master Builders Solutions. The detail is subject to change without notice. Master Builders Solutions accepts no liability for the end use of the detail. For conditions not shown, consult Master Builders Solutions for review of specific detail.

Senershield-R/-RS/-VB

TYPICAL WINDOW HEAD

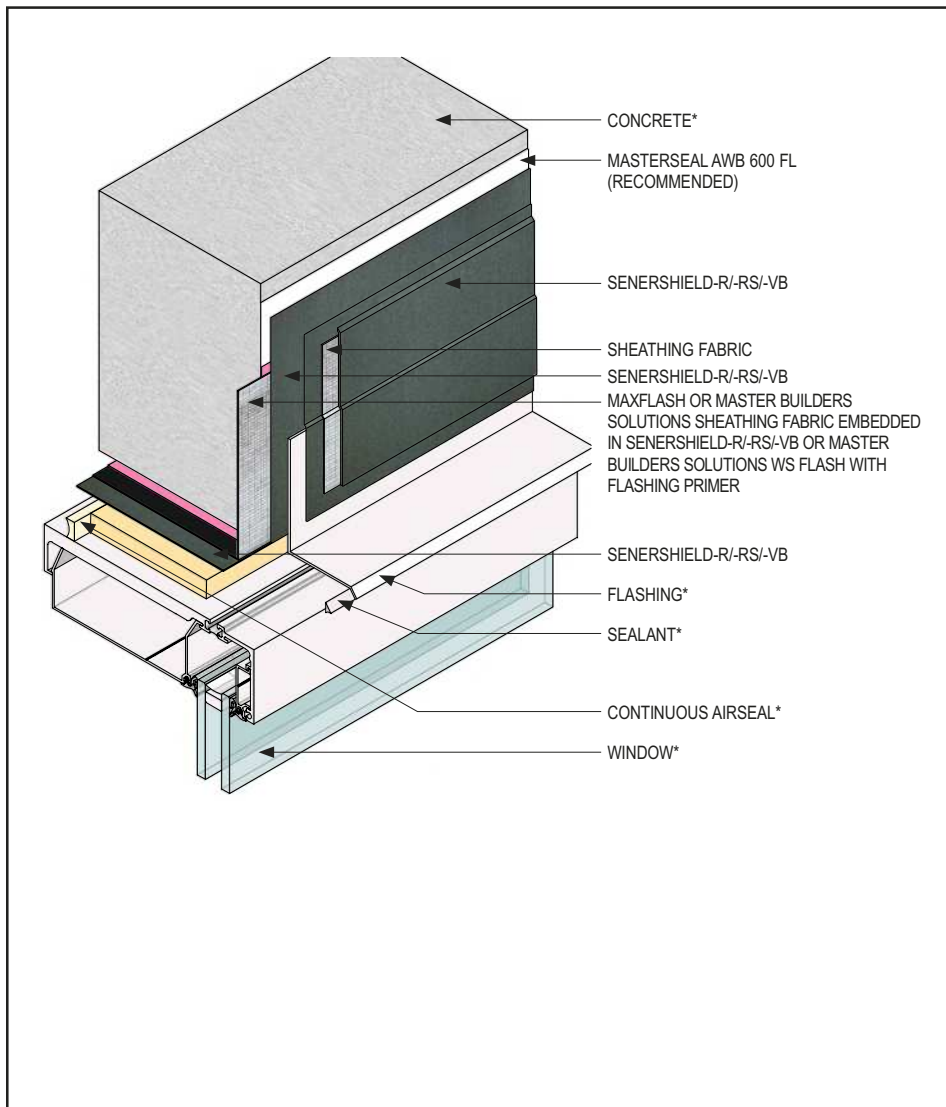

- Install Master Builders Solutions materials in accordance with current installation instructions.
- Unsatisfactory conditions shall be reported to the General Contractor and corrected before the application of Master Builders Solutions products.
- Embed Sheathing Fabric in Senershield-R/-RS/-VB.
- Provide end dams at flashing terminations.
- If blocking is installed prior to Senershield-R/-RS/-VB application, it shall be treated as a rough opening; verify adhesion before proceeding.
- Either Master Builders Solutions WS Flash with Master Builders Solutions Flashing Primer or Sheathing Fabric can be used. See AWRB-CMU-04, AWRB-CMU-07 and AWRB-CMU-08.

CMU-21 2108

(*NOTE: BY OTHERS)

This detail represents Master Builders Solutions Construction Systems US, LLC (hereinafter Master Builders Solutions) latest recommendations. It is presented in good faith by Master Builders Solutions. The detail is subject to change without notice. Master Builders Solutions accepts no liability for the end use of the detail. For conditions not shown, consult Master Builders Solutions for review of specific detail.

Senershield-R/-RS/-VB

TYPICAL WINDOW SILL

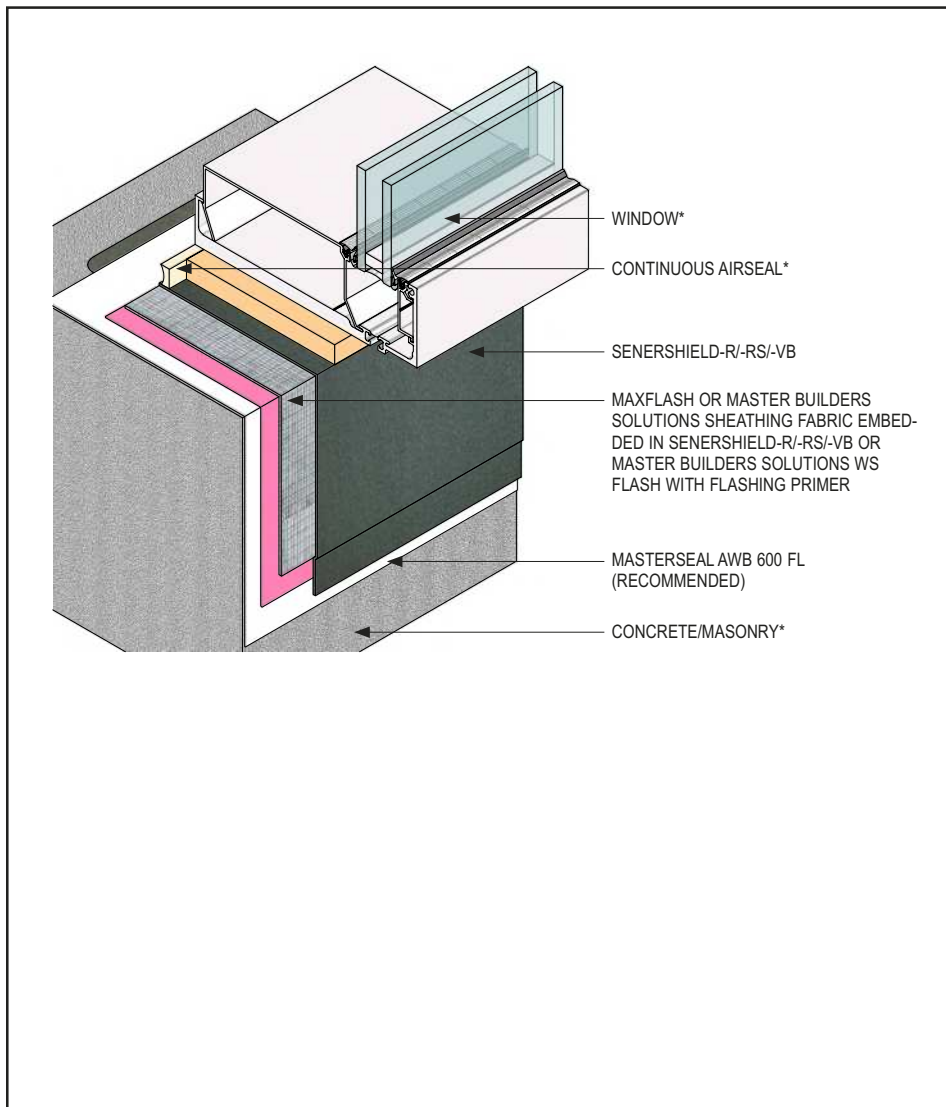

- Install Master Builders Solutions materials in accordance with current installation instructions.
- Unsatisfactory conditions shall be reported to the General Contractor and corrected before the application of Master Builders Solutions products.
- Install end/back dams as required.
- If blocking is installed prior to Senershield-R/-RS/-VB application, it shall be treated as a rough opening; verify adhesion before proceeding.
- Either Master Builders Solutions WS Flash with Master Builders Solutions Flashing Primer or Sheathing Fabric can be used. See AWRB-CMU-04, AWRB-CMU-07 and AWRB-CMU-08.
- Fill CMU cores solid flush.

CMU-22 2108

(*NOTE: BY OTHERS)

This detail represents Master Builders Solutions Construction Systems US, LLC (hereinafter Master Builders Solutions) latest recommendations. It is presented in good faith by Master Builders Solutions. The detail is subject to change without notice. Master Builders Solutions accepts no liability for the end use of the detail. For conditions not shown, consult Master Builders Solutions for review of specific detail.

Senersshield-R/-RS/-VB

TYPICAL ROOF EDGE OR PARAPET CAP FLASHING

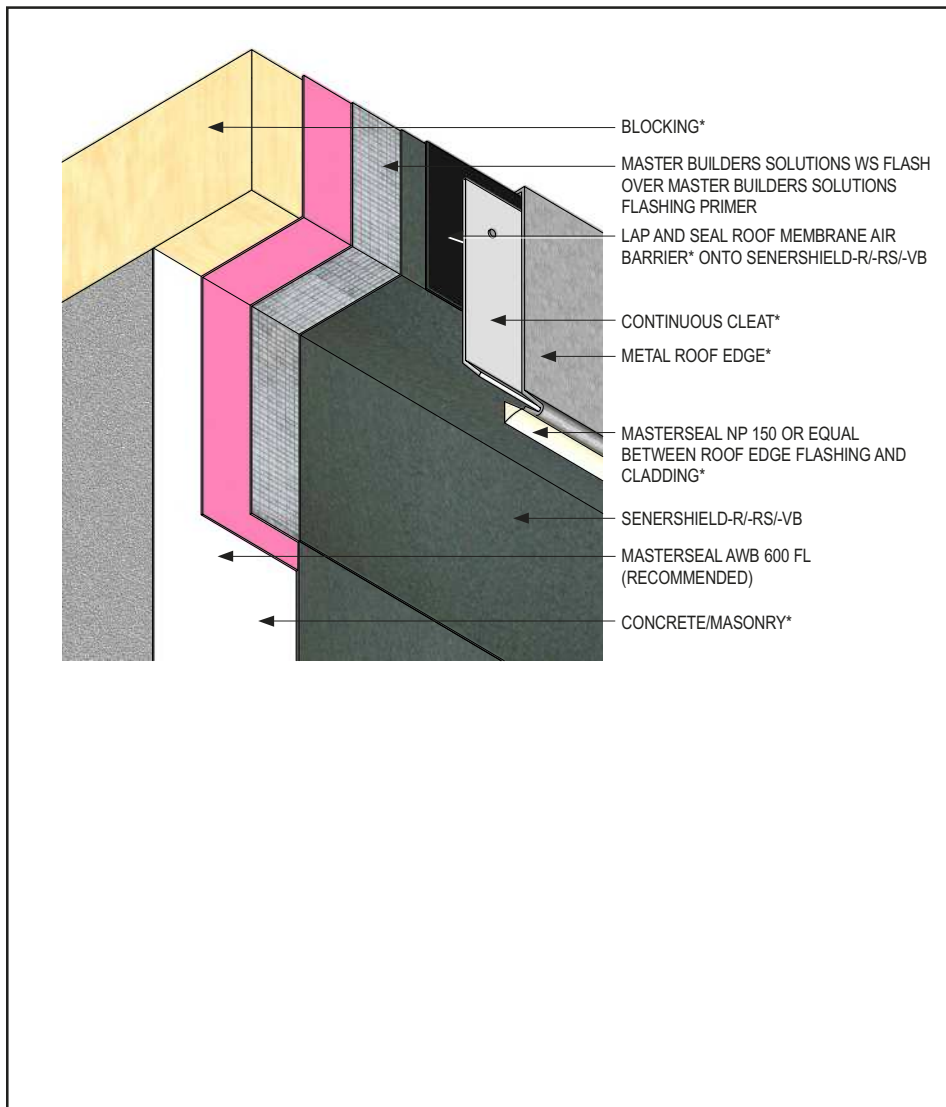

- Install Master Builders Solutions materials in accordance with current installation instructions.
- Unsatisfactory conditions shall be reported to the General Contractor and corrected before the application of Master Builders Solutions products.
- Either Master Builders Solutions WS Flash with Flashing Primer or Sheathing Fabric can be used to provide an air/water-resistive barrier at transition of sheathing to blocking.
- Avoid solvent-based adhesives/primers where roofing laps Senergy.

CMU-23 2108

(*NOTE: BY OTHERS)

This detail represents Master Builders Solutions Construction Systems US, LLC (hereinafter Master Builders Solutions) latest recommendations. It is presented in good faith by Master Builders Solutions. The detail is subject to change without notice. Master Builders Solutions accepts no liability for the end use of the detail. For conditions not shown, consult Master Builders Solutions for review of specific detail.

Warranty

Master Builders Solutions Construction Systems US, LLC ("Master Builders") warrants this product to be free from manufacturing defects and to meet the technical properties on the current Technical Data Guide, if used as directed within shelf life. Satisfactory results depend not only on quality products but also upon many factors beyond our control. Master Builders **MAKES NO OTHER WARRANTY OR GUARANTEE, EXPRESS OR IMPLIED, INCLUDING WARRANTIES OF MERCHANTABILITY OR FITNESS FOR A PARTICULAR PURPOSE WITH RESPECT TO ITS PRODUCTS.** The sole and exclusive remedy of Purchaser for any claim concerning this product, including but not limited to, claims alleging breach of warranty, negligence, strict liability or otherwise, is shipment to purchaser of product equal to the amount of product that fails to meet this warranty or refund of the original purchase price of product that fails to meet this warranty, at the sole option of Master Builders. Any claims concerning this product must be received in writing within one (1) year from the date of shipment and any claims not presented within that period are waived by Purchaser. Master Builders **WILL NOT BE RESPONSIBLE FOR ANY SPECIAL, INCIDENTAL, CONSEQUENTIAL (INCLUDING LOST PROFITS) OR PUNITIVE DAMAGES OF ANY KIND.**

Purchaser must determine the suitability of the products for the intended use and assumes all risks and liabilities in connection therewith. This information and all further technical advice are based on Master Builders' present knowledge and experience. However, Master Builders assumes no liability for providing such information and advice including the extent to which such information and advice may relate to existing third party intellectual property rights, especially patent rights, nor shall any legal relationship be created by or arise from the provision of such information and advice. Master Builders reserves the right to make any changes according to technological progress or further developments. The Purchaser of the Product(s) must test the product(s) for suitability for the intended application and purpose before proceeding with a full application of the product(s). Performance of the product described herein should be verified by testing and carried out by qualified experts.

For professional use only. Not for sale to or use by the general public.